

Steel Manufacturing Process

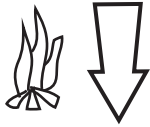

raw materials

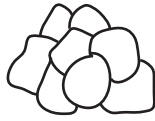
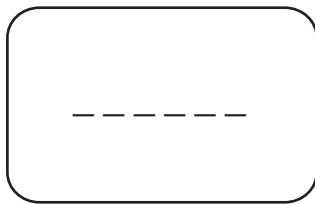
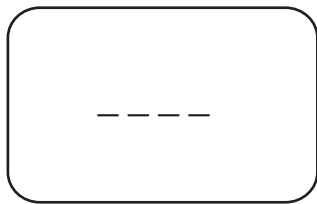
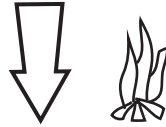

billets, casts, cement, coal, coke, iron ore, limestone, manganese, nickle, pig iron, road base, scrap metal, sinter, slabs, slag, steel, stainless steel

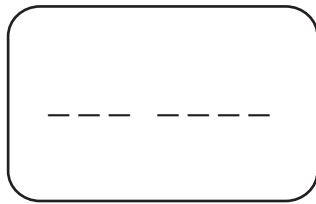

flux material

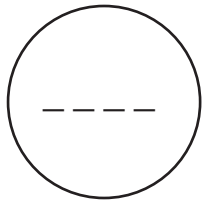

recycled material



additives

or _____



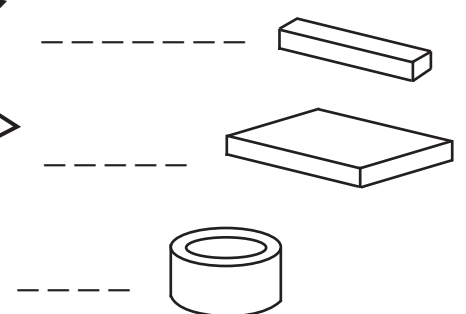
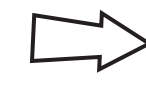
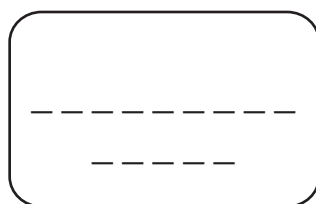

How Is Stainless Steel Made ?